

USER MANUAL

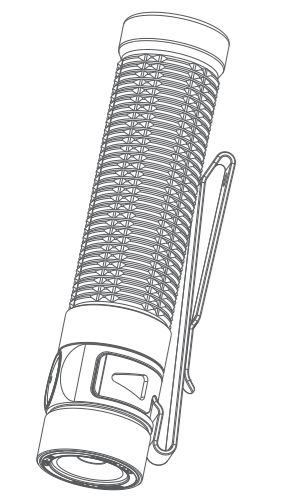

Baton 3 Pro
A powerful compact rechargeable side switch flashlight.

IN THE BOX

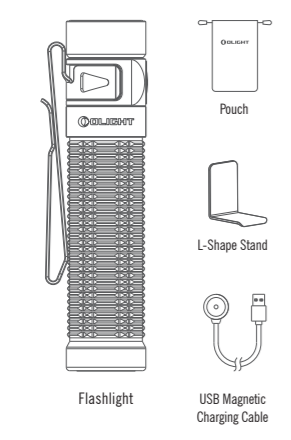

Table 1: Flashlight

Table with 2 columns: Mode and Duration. Rows include TURBO (1,500 lumens), HIGH (600 lumens), MEDIUM (120 lumens), LOW (15 lumens), and MOONLIGHT (0.5 lumens).

Table 2: USB Magnetic charging cable. Cable length: 0.5m. Input: USB-A 5V 2A. Output: CC&CV 4.2V±0.05V 2.0A. Time to fully charge: About 3.5 hours.

Table 2: USB Magnetic charging cable

Figure 1

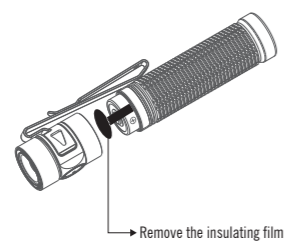

Figure 2

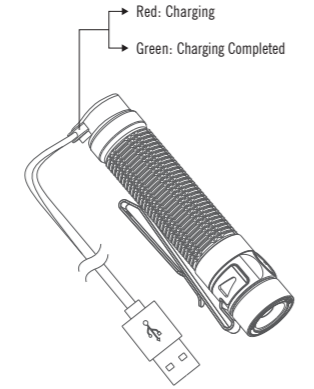

Figure 3

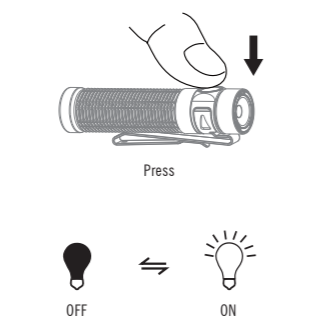

Figure 4

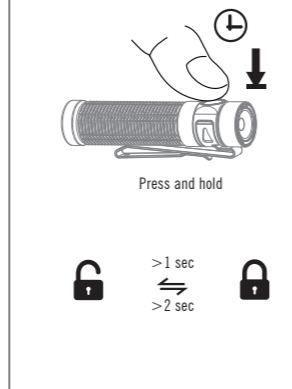

Figure 5

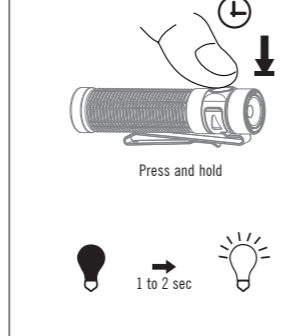

Figure 6

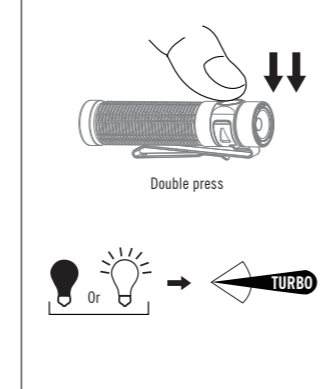

Figure 7

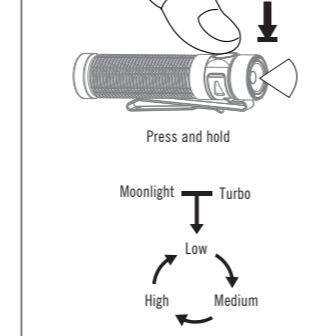

Figure 8

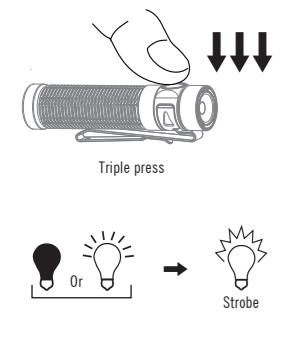

Figure 9

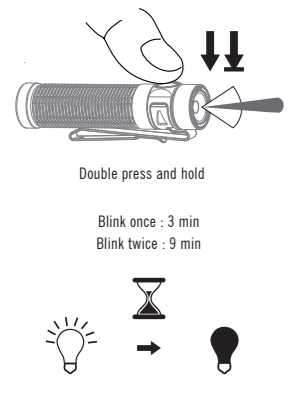

Figure 10-1

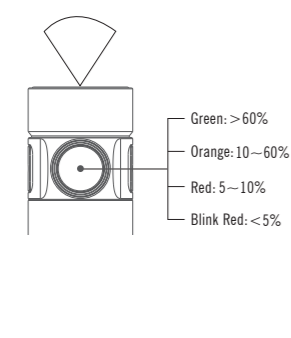

Figure 10-2

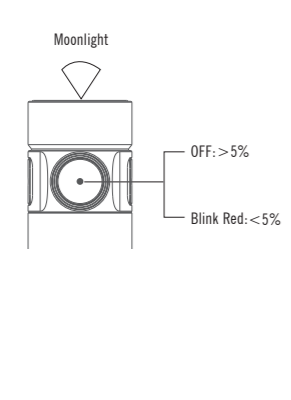
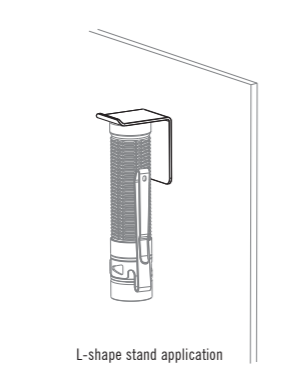

Figure 11



CONTENTS

Table listing contents for various languages: (EN) English, (CN) 简体中文, (FI) Finnish, (NO) Norwegian, (SV) Swedish, (NL) Nederlands, (PL) Polska, (DE) Deutsch, (HU) Magyarorszag, (ES) Español, (UA) Ukrainian, (KR) 한국어, (TH) ไทย, (FR) Français, (IT) Italiano, (SK) Slovenskýjazyk, (PT) Português.

(EN) English

Multi-language dictionary, see Table 3; 1. Product specification, see Table 1 and Table 2; 2. Operating instructions as below: 2.1 Remove the insulating film, see Figure 1; 2.2 Charging, see Figure 2; 2.3 ON/OFF, see Figure 3; 2.4 Lockout / unlock, see Figure 4; 2.5 Moonlight, see Figure 5; 2.6 TURBO, see Figure 6; 2.7 Change brightness level, see Figure 7; 2.8 Strobe, see Figure 8; 2.9 Set timer, see Figure 9; 2.10 Battery Indicator: Normal mode, see Figure 10-1; Moonlight mode, see Figure 10-2; 2.11 L-shape stand application, see Figure 11.

(CN) 简体中文

多语言字典, 参见 Table 3; 1. 产品参数参见 Table 1与Table 2; 2. 操作指引见下: 2.1 使用前移除绝缘片, 参见Figure 1; 2.2 充电, 参见Figure 2; 2.3 开/关手电, 参见Figure 3; 2.4 锁键/解锁, 参见Figure 4; 2.5 月光档, 参见Figure 5; 2.6 TURBO档, 参见Figure 6; 2.7 改变亮度, 参见Figure 7; 2.8 爆闪, 参见Figure 8; 2.9 定时, 参见Figure 9; 2.10 电量指示灯说明, 非Moonlight模式, 参见Figure 10-1; Moonlight模式, 参见Figure 10-2; 2.11 支架应用, 参见 Figure 11.

(FI) Finnish

Monikielinen sanakirja, katso Table 3; 1. Tututteen tekniset tiedot, katso Table 1 ja Table 2; 2. Käyttöohjeet: 2.1 Suojakalvon poistaminen, katso Figure 1; 2.2 Lataaminen, katso Figure 2; 2.3 Käynnistys/Sammuttaminen, katso Figure 3; 2.4 Lukitus/Lukituksen avaaminen, katso Figure 4; 2.5 Moonlight-asetus, katso Figure 5; 2.6 TURBO-asetus, katso Figure 6;

(NO) Norwegian

Flerspråklig ordbok, se Table 3; 1. Produktspesifikasjon, se Table 1 og 2; 2. Bruksanvisning som nedenfor: 2.1 Fjern isolasjonsfilmen, se Figure 1; 2.2 Lading, se Figure 2; 2.3 PÅ/AV, se Figure 3; 2.4 Knappelås, se Figure 4; 2.5 Moonlight, se Figure 5; 2.6 TURBO, se Figure 6; 2.7 Endre lysstyrkenivå, se Figure 7; 2.8 Strobe, se Figure 8; 2.9 Tidsinnstilling, se Figure 9; 2.10 Batteriindikator: Normal modus, se Figure 10-1; Moonlight, se Figure 10-2; 2.11 L-formet stativapplikasjon, se Figure 11.

(SV) Swedish

Flerspråklig ordbok, se Table 3; 1. Produktspekifikation, se Table 1 och 2; 2. Bruksanvisning enligt nedan: 2.1 Avlägsna skyddspåsten, se Figure 1; 2.2 Laddning, se Figure 2; 2.3 PÅ/AV, se Figure 3; 2.4 Knapplös, se Figure 4; 2.5 Moonlight, se Figure 5; 2.6 TURBO, se Figure 6; 2.7 För att ändra ljusstyrka, se Figure 7; 2.8 Strobe, se Figure 8; 2.9 Tidsinställning, se Figure 9; 2.10 Batteriindikator: Normalt läge, se Figure 10-1; Moonlight, se Figure 10-2; 2.11 L-format stativapplikation, se Figure 11.

(NL) Nederlands

Meertalig woordenboek, zie Table 3;

Table 3 Multi-language dictionary

Table with 12 columns: EN, Moonlight, Low, Medium, High, Turbo, Strobe, Press, Double press, Press and hold, Triple press, Blink once, Blink twice. Rows include CN, FI, NO, SV, NL, PL, DE, HU, RU, ES, RO, UA, JP, KR, TH, FR, IT, SK, PT.

1. Productspecificatie, zie Table 1 en Table 2; 2. Gebruiksaanwijzing zoals hieronder: 2.1 Verwijder de isolatiefilm (zie Figure 1); 2.2 Opladen (zie Figure 2); 2.3 AN/UIT (zie Figure 3); 2.4 Vergrendelen/ontgrendelen (zie Figure 4); 2.5 Maanlichtmodus (zie Figure 5); 2.6 Turbomodus (zie Figure 6); 2.7 Helderheidsniveau wijzigen (zie Figure 7); 2.8 Stroboscoopmodus (zie Figure 8); 2.9 Timer instellen (zie Figure 9); 2.10 Batterij-indicator: Normale modus, zie Figure 10-1; Maanlichtmodus (zie Figure 10-2); 2.11 L-vormige staander toepassing, zie Figure 11.

(HU) Magyarorszag
Többnyelvű szótár, lásd Table 3; 1. Műszaki adatok. Lásd Table 1. és Table 2. 2. Használati útmutató az alábbiakban: 2.1 Távolítsa el a szigetelő lapkát. Lásd Figure 1. 2.2 Töltés. Lásd Figure 2. 2.3 BE/KI. Lásd Figure 3. 2.4 Lezárási/feloldási. Lásd Figure 4. 2.5 Hőfény mód. Lásd Figure 5. 2.6 Turbó. Lásd Figure 6. 2.7 Fényerő megváltoztatása. Lásd Figure 7. 2.8 Stroboszkóp. Lásd Figure 8. 2.9 Időtűző beállítás. Lásd Figure 9. 2.10 Akkumulátor kijelzés: Normál mód. Lásd Figure 10-1. Hőfény mód. Lásd Figure 10-2. 2.11 L alakú álló alkalmazás, lásd Figure 11.

(PL) Polska
Słownik wielojęzyczny, zob. Table 3; 1. Specyfikacja produktu, zobacz Table 1 i Table 2; 2. Instrukcja obsługi jak poniżej: 2.1 Usunąć folię izolacyjną, zobacz Figure 1; 2.2 Ładowanie, zobacz Figure 2; 2.3 Włącz/Wyłącz, zobacz Figure 3; 2.4 Blokadowanie/Odblokowanie, zobacz Figure 4; 2.5 Moonlight, zobacz Figure 5; 2.6 TURBO, zobacz Figure 6; 2.7 Zmiana poziomu jasności, zobacz Figure 7; 2.8 Stroboskop, zobacz Figure 8; 2.9 Ustawienie timera, zobacz Figure 9; 2.10 Wskaźnik baterii: tryb normalny, zobacz Figure 10-1; tryb Moonlight, zobacz Figure 10-2; 2.11 Statyw w kształcie L, zobacz Figure 11.

(RO) Românesc
Dicționar multilingv, a se vedea Table 3; 1. Specificațiile produsului, vezi Table 1 și Table 2; 2. Instrucțiuni utilizare: 2.1 Îndepărtarea plasticului de siguranță, vezi Figure 1; 2.2 Încărcare, vezi Figure 2; 2.3 Pornit/Opriți, vezi Figure 3; 2.4 Blocare/Deblocare, vezi Figure 4; 2.5 Mod de veghe, vezi Figure 5; 2.6 TURBO, vezi Figure 6; 2.7 Schimbare nivel iluminare, vezi Figure 7; 2.8 Stroboscop, vezi Figure 8; 2.9 Setarea timpului, vezi Figure 9; 2.10 Indicator baterie: Mod normal, vezi Figure 10-1; Mod de veghe, vezi Figure 10-2; 2.11 Aplicația standului în formă de L, a se vedea Figure 11.

(RU) Русский
Многоязычный словарь, смотрите Table 3; 1. Технические характеристики изделия см. Table 1 и 2. 2. Инструкция по эксплуатации, как указано ниже: 2.1 Снимите изоляционную пленку, см. Figure 1; 2.2 Зарядка, см. Figure 2; 2.3 ВКЛ/ВЫКЛ, см. Figure 3; 2.4 Блокировка/разблокировка, см. Figure 4; 2.5 Лунный свет, см. Figure 5; 2.6 Турбо, см. Figure 6; 2.7 Изменение уровня яркости, см. Figure 7; 2.8 Стробоскоп, см. Figure 8; 2.9 Установка таймера, см. Figure 9; 2.10 Индикатор заряда батареи: Обычный режим, см. Figure 10-1; Режим лунного света, см. Figure 10-2; 2.11 Применение L-образной стойки, смотрите Figure 11.

(DE) Deutsch
Mehrsprachiges Wörterbuch, siehe Table 3; 1. Produktspezifikationen, siehe Table 1 und Table 2; 2. Bedienhinweise wie folgt: 2.1 Isolierfolie entfernen, siehe Figure 1; 2.2 Aufladen, siehe Figure 2; 2.3 EIN-/AUSSCHALTEN, siehe Figure 3; 2.4 Sperren/Entriegeln, siehe Figure 4; 2.5 Mondlicht, siehe Figure 5; 2.6 TURBO, siehe Figure 6; 2.7 Helligkeitsstufe ändern, siehe Figure 7; 2.8 Stroboskoplicht, siehe Figure 8; 2.9 Timer einstellen, siehe Figure 9; 2.10 Akkuanzeige: Normalmodus, siehe Figure 10-1; Moonlichtmodus, siehe Figure 10-2; 2.11 L-förmiger Ständer, siehe Figure 11.

(JP) 日本語
多言語辞書はTable 3を参照してください。 1. 製品仕様はTable 1およびTable 2を参照してください。 2. 操作手順: 2.1 絶縁フィルムを取り除きます。Figure 1を参照してください。 2.2 充電方法はFigure 2を参照してください。 2.3 オン/オフはFigure 3を参照してください。 2.4 ロックアウト/ロック解除はFigure 4を参照してください。 2.5 ムーンライトモードの切替方法はFigure 5を参照してください。 2.6 ターボモードの切替方法はFigure 6を参照してください。 2.7 輝度レベルの変更はFigure 7を参照してください。 2.8 ストロボモードの切替方法はFigure 8を参照してください。 2.9 タイマーの設定はFigure 9を参照してください。 2.10 バッテリーインジケータ:通常モード, Figure 10-1を参照してください。ムーンライトモード, Figure 10-2を参照してください。 2.11 L字型スタンドの用途はFigure 11を参照してください。

WARRANTY

Within 30 days of purchase: Contact the original seller for repair or replacement. Within 5 years of purchase: Contact Olight for repair or replacement. Battery warranty: Olight offers a one-year warranty for all rechargeable batteries. MCC magnetic USB charging cable: One year. For any of the fragile or low-value fittings not covered above, like lanyard and clip, you can contact the post-sale within 30 days of the purchase, if it has any quality drawback or damage under normal use condition. If such drawback or damage occurs after 30 days of the purchase or under abnormal use condition, we will only offer conditional quality assurance as appropriate.

USA Customer Support cs@olightstore.com Global Customer Support contact@olightworld.com Visit www.olightworld.com to see our complete product line of portable illumination tools.

O LIGHT Dongguan Olight E-Commerce Technology Co., Ltd 4th Floor, Building 4, Hegu Industrial Park, No 6 Zhongnan Road, Changan Town, Dongguan City, Guangdong, China. Made in China. RoHS, CE, UK, CA, FC logos. 3.4000.0504 C. 10, 26, 2022